



# Self-Propelled Electric Scissor Lift

MX1930



# Self-Propelled Electric Scissor Lift

## MX1930





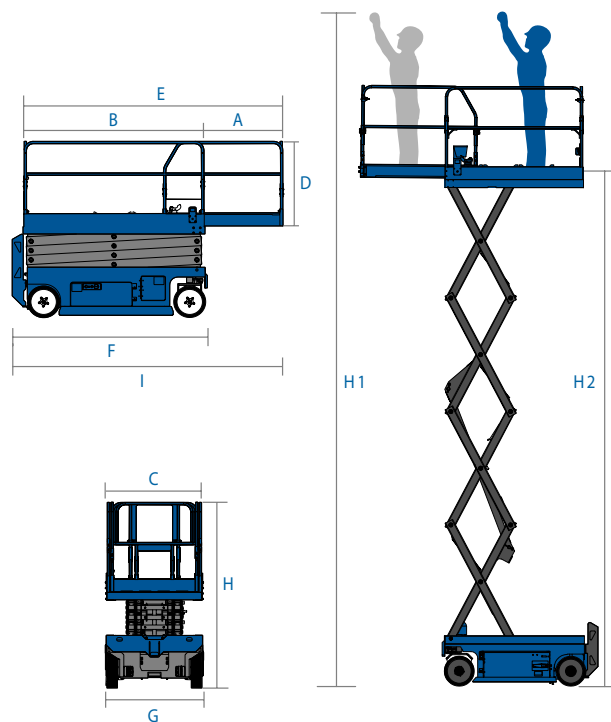



### STANDARD EQUIPMENT

- Proportional controls for lift and drive functions.
- Automatic 25Amp Battery charger.
- Automatic stop protection when platform lowering down.
- Manual Emergency platform lowering valve if no power.
- Emergency stop on platform and ground controls.
- Safety warning signal and light when the lift is operating
- Tilt sensor with the alarm.
- AC - line from the chassis to the platform.
- Hour meter
- Lifting points & Forklift pockets
- Diagnostic system



### SPECIFICATIONS

#### MX1930

	Working height max. (H1)	7.8m
	Platform height max. (H2)	5.8m
	Platform outreach (A)	0.9m
	Lifting capacity	230kg
	Lifting capacity on platform extension	115kg
	Weight	1490kg
	Platform size (LxWxH) (BxCxD)	1.64 x 0.75 x 1.1m
	The length of platform extended (E)	2.54m
	Stowed size (LxW) (FxG)	1.85 x 0.77m
	Stowed height (H)	2.13m
	Length of machine with platform extended (I)	2.75m
	Height of machine with platform folded	1.78m
	Gradeability	30%
	Wheelbase	1.32m
	Ground clearance	0.06m
	Pothole protection board ground clearance	0.02m
	Inside rotation radius	0
	Outside turning radius	1.56m
	Load number max	2
	Raised time/Lowering time	14/11s
	Traction/safe speed	3.8km/h 0.7km/h
	Vertical/lateral tilt grade	2°/1.5°
	Power source	4 x 6V/225Ah
	Tyre size, solid, non-marking	356 x 114 x 254mm



**CE APPROVED**

[www.instantuprightlifts.com](http://www.instantuprightlifts.com)

**INSTANT**

**Norway**

Tel.: +47 23 19 11 00  
info@instant.no

**Lithuania**

Tel.: +370 5 233 1096  
info@instant.lt

**Latvia**

Tel.: +371 263 58 152  
info@instantlatvija.lv

**Estonia**

Tel.: +372 680 76 33  
info@instanteesti.ee